



PTC00100FG

100 litre Free Standing Cartage Tank

Unit Specifications

Item	Description	Details
Tank	100 litre	UV stabilised polyethylene specially formulated for transport tanks. Complies with AS2070:1999 & AS4766:2006 compliant. Food grade with 10 year guarantee.
Lid	150mm	150mm diameter screw lid fitted with spring breather valve and gasket
Tank outlet	3/4"	3/4" poly drain bung & seal
Dimensions	PTC00100FG	900mm(L) x 450mm(W) x 475mm(H)
Dry weight		11kg
Baffles		No baffle
Colour		Faint green
Load Rating		1.3 Specific Gravity (SG)

1

Active Liquid Tanks Specification Sheet

Features

- Unconditional guarantee against rust
- Extraordinary impact resistance
- Impressive range of 'flex' to cope with chassis movement and twisting in tough operating conditions
- Calibrated for measurement of contents
- Mounts directly to any flat surface
- Spill containment lip surrounds lid
- Australian made for Australian conditions
- Optional tank colours available

For Use

- Potable (drinking water delivery)
- Dust suppression units
- Liquid fertiliser transport
- Water supply for spraying contractors
- Drillers mud
- Molasses transport

Dimensional Drawing – PTC00100FG

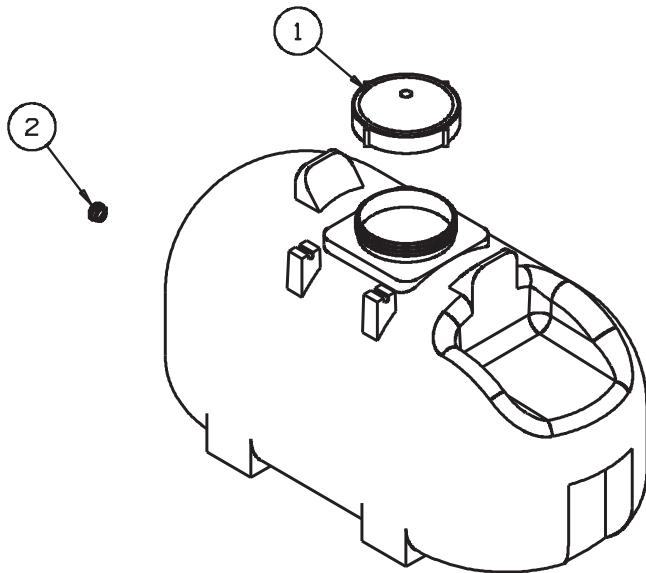

OVERALL DIMENSIONS 900(L) X 450(W) X 475(H)

ITEM	CODE	Description
1	ARLP150AV	Ø150 Screw Lid & Seal
2	CFNB20M	3/4" Poly Drain Bung & Seal

2