

Active Liquid Tanks Specification Sheet



PTC01200FG

1200 litre Free Standing Cartage Tank

Unit Specifications

Item	Description	Details
Tank	1200 litre	UV stabilised polyethylene specially formulated for transport tanks. Complies with AS2070:1999 & AS4766:2006 compliant. Food grade with 10 year guarantee.
Lid	455mm	455mm diameter lid, rim & seal. 180° hinged tank lid supplied with fixing ring. Labyrinth breather valve. Gasket seal. Six point bayonet lock to provide perfect seal, UV stabilised polypropylene construction. Spill containment lip surrounds lid
Tank outlet	1 1/2" MBSP	Flanged polypropylene tank outlet fitting complete with nut & washer
Dimensions	PTC01200FG	1700mm(L) x 1320mm(W) x 860mm(H)
Dry weight		70kg
Baffles		Integral foam filled baffle
Colour		Faint green
Load Rating		1.3 Specific Gravity (SG)
Mounting	4 x 24 x 260mm Tank Mounting Pins	Mounts directly to any flat surface with galvanised steel mounting pins (optional)

1

Active Liquid Tanks Specification Sheet

Features

- Unconditional guarantee against rust
- Extraordinary impact resistance
- Australian made for Australian conditions
- Optional tank colours available
- Extra fittings can be added almost anywhere
- Large tank opening for fast, easy filling
- Extra-thick tank structure with a load rating of up to an enormous 1.3:1 specific gravity on all Active tanks
- Specifically moulded fittings to enable easy mounting to any flat surface...without the need for any frame
- In-built 'Flexi-Link® Technology' in each tank structure allows real flex to cope with those truck chassis twist and moves that happen during tough operating conditions
- Specialised poly manufacturing process maximises strength with minimal weight resulting in greater payload opportunities
- Easy to read calibration on tank side for quick measurement of contents
- Ideal for safe and secure transporting of a wide range of fluids
- Easy fill /No spill containment lip on tanks over 400 litres
- 'Surefit' tank mounting pin kit and poly outlet supplied with tanks

Applications

- Potable (drinking water delivery)
- Dust suppression units
- Liquid fertiliser transport
- Water supply for spraying contractors
- Drillers mud
- Molasses transport
- Agricultural chemical transport and mixing

What is Flexi-Link® Technology?

- A polymer formulation with unique molecular bonding technology that allows flex without loss of strength

Dimensional Drawing – PTC01200FG

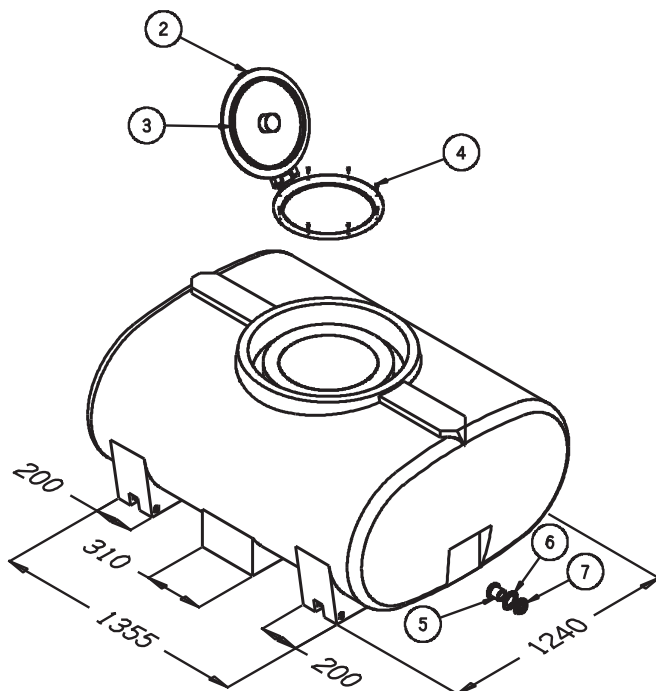

OVERALL DIMENSIONS 1700(L) X 1320(W) X 860(H)

ITEM	CODE	Description
2	ARLP450VSR	Ø455 Lid, Rim & Seal Assy
3		Ø455 Lid Seal Only
4		Stainless Steel Screws
5,6,7	ARFP038	1 1/2" MBSP Fitting - Poly

*Rapid spray warranty requires fitting the Ball Baffle System to tanks larger than 6000 litres partially filled