



PTSP04400KFG

## 4400 Litre Pin Mount Spray Tank with Galvanised Steel Frame

### Unit Specifications

Item	Description	Details
Tank	4400 litre	Manufactured from UV stabilised polyethylene specifically formulated for chemical spray tanks. Complies with AS2070:1999 & AS4766:4006. Integral fully draining sump. 10 year guarantee.
Lid	455mm	Ø455mm hinged lid, rim and seal. 180° hinged tank lid. Supplied with fixing ring labyrinth breather valve. Gasket seal. Six point bayonet lock to provide perfect seal. UV stabilised polypropylene construction. Spill containment lip surrounds lid.
Filter	Basket Filter	Ø410mm x 225mm deep with 18 mesh screen
Tank outlet	2" MBSP	Flanged polypropylene tank outlet fitting complete with nut and washer
Dimensions	PTSP04400FG (Tank Only)	2960mm(L) x 1450mm(W) x 1600mm(H)
	PTSP04400KFG (Tank and Frame)	2960mm(L) x 1450mm(W) x 1650mm(H)
Dry weight	PTSP04400FG	175kgs
	PTSP04400KFG	355kgs
Colour		Faint green
Load rating		1.3 Specific Gravity (SG)
Mounting	Galvanised steel mounting frame & pins 6 x 24 x 330mm	Hot dipped galvanised steel mounting frame and pins for correct tank support and to give sump clearance for access

1

# Spray Tanks Specification Sheet

## Features

- Integral fully draining sump
- The positive draining tank base with centred sump provides flooded suction regardless of terrain
- Unconditional guarantee against rust
- Extraordinary impact resistance
- Impressive range of "flex" to cope with movement and twisting in tough operating conditions
- Impervious to most chemicals
- Easy to read calibrations for measurement of contents
- Australian made for Australian conditions
- 10 year guarantee – buy with confidence!

## Dimensional Drawing – PTSP04400FG / PTSP04400KFG

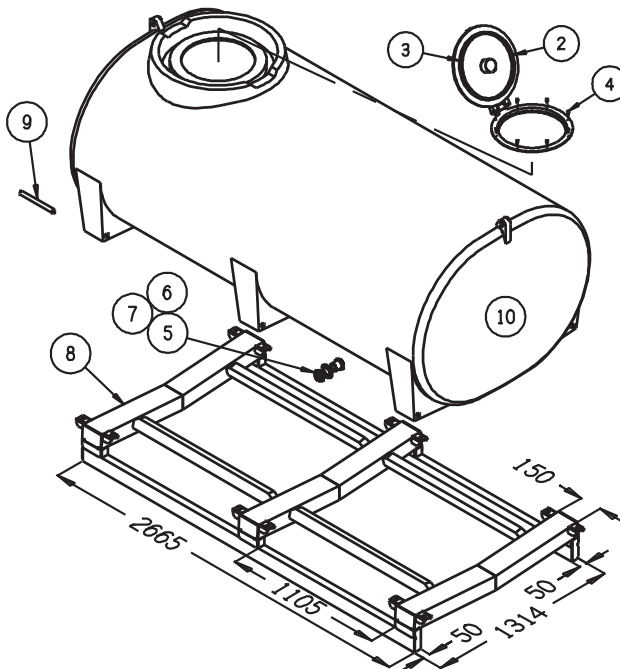

Cutaway shows full drain sump



End view shows sump clearance



Outside view of Pin



Cutaway of Pin

**OVERALL DIMENSIONS** 2960(L) X 1450(W) X 1650(H)

2

ITEM	CODE	Description
1	ARK400	ø455 Filter Basket
2	ARLP450VSR	ø455 Lid, Rim & Seal Assy
3		ø455 Lid Seal Only
4		Stainless Steel Screws
5,6,7	ARFP050	2" MBSP Fitting-Poly
8		Skid Frame Only
9	ARP006	6 Pins 24x330
10	PTSP04400FG	4400L Tank - Bare

## Optional Tank Colours

### Standard

### Translucent



Faint Green



Natural



Trans Yellow



Trans Blue

- Optional colours will incur a surcharge of 5%
- If water is being stored in tank we recommend using opaque colours to prevent algae growth

### Opaque



Rapid Blue



Light Blue



Heritage Green



Rapid Yellow



Red



White



Light Grey



Black

## Optional Large Ball Baffle

– ARB355 Ø355MM

Displaces 428ml and weighs 386g. Recommended use quantity 1 ball baffle per 40L of tank capacity



\*Tanks not mounted in accordance with our specifications may void warranty

Freecall 1800 011 000  
www.rapidspray.net

