

Dry boom non-drip nozzle assembly complete

STAN025

3/8" Barbed Elbow Nozzle Holder with diaphragm check valve

100 # filter, 110° flat fan nozzle (Choice of 5 sizes) and quick coupling cap and washer

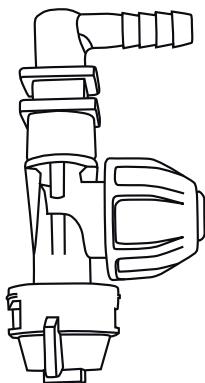

STAN026

3/8" Barbed Tee with diaphragm check valve

100 # filter, 110° flat fan nozzle (Choice of 5 sizes) and quick coupling cap and washer

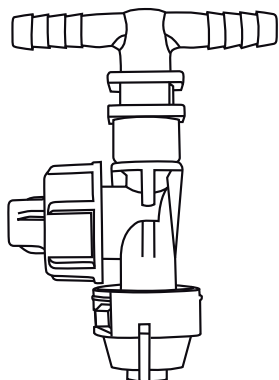

STAN027

3/8" Barbed Cross with diaphragm check valve

100 # filter, 110° flat fan nozzle (Choice of 5 sizes) and quick coupling cap and washer

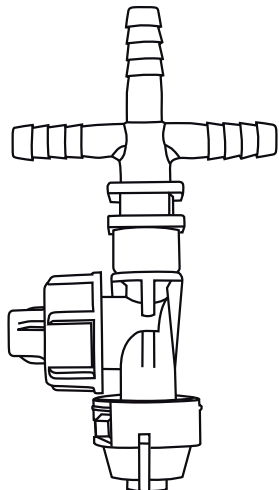

Wet boom non-drip nozzle assembly complete (suits 1/2" pipe)

STAN024

Clamp Type Nozzle Holder to suit 1/2" Pipe

('O' ring included) with diaphragm check valve

100 # filter, 110° flat fan nozzle (Choice of 5 sizes) and quick coupling cap and washer

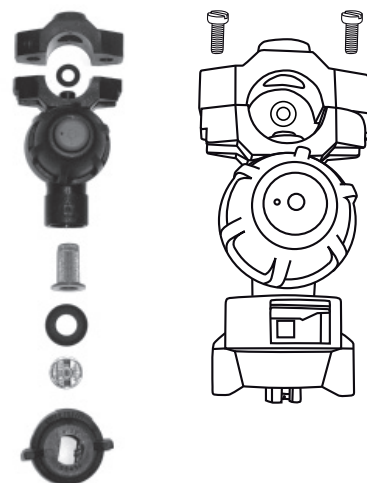

STAN033

Hinged Type Nozzle Holder to suit 1/2" Pipe

('O' ring included) with diaphragm check valve

100 # filter, 110° flat fan nozzle (Choice of 5 sizes) and quick coupling cap and washer

Screw also supplied

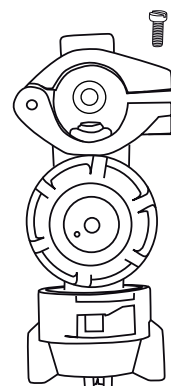

STAN034

1/4" BSP Male Threaded Nozzle Holder

('O' ring included) with diaphragm check valve

100 # filter, 110° flat fan nozzle (Choice of 5 sizes) and quick coupling cap and washer

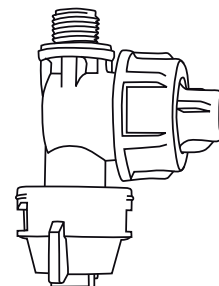

Dry boom nozzle assembly complete

STAN028

3/8" Barbed Cross
Nozzle Holder

With quick coupling
cap and washer and
110° flat fan nozzle

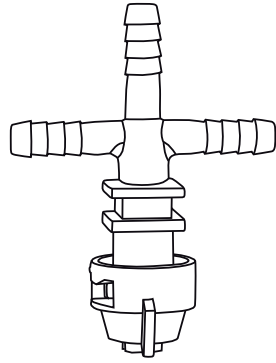

STAN029

3/8" Barbed Elbow
Nozzle Holder

With quick coupling
cap and washer and
110° flat fan nozzle

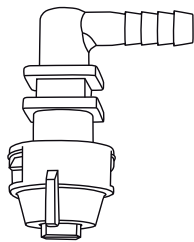

STAN030

3/8" Barbed Tee
Nozzle Holder

With quick coupling
cap and washer and
110° flat fan nozzle

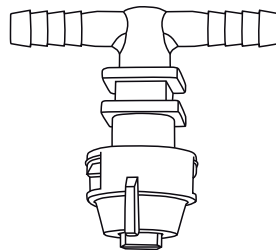

STAN031

Off Centre End Jet
Assembly Complete
for Versatile Booms

Includes:

3/8" barbed elbow
with 1/4" FBSP

1/4" BSP MF ball valve

1/4" BSP swivel coupling
nozzle holder

with 3/8" brass nut & seal

and brass OC4 nozzle

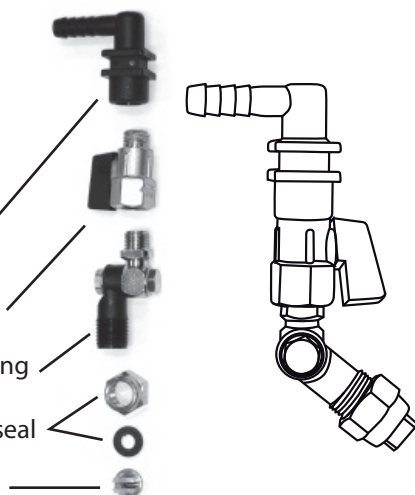

Non-drip dry boom nozzle bodies

STAB026

3/8" Barbed Tee
Nozzle Holder

With diaphragm
check valve

Suits quick coupling cap

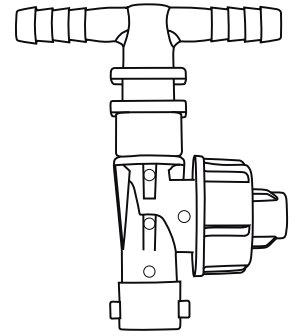

STAB025

3/8" Barbed Elbow
Nozzle Holder

With diaphragm
check valve

Suits quick coupling cap

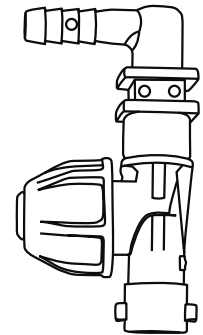

STAB042

3/8" Barbed Cross
Nozzle Holder

With diaphragm
check valve

Suits quick coupling cap

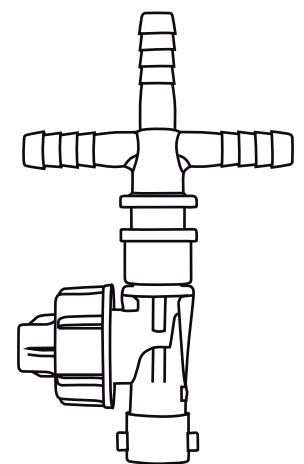

Non-drip wet boom nozzle bodies

STAB044

Hinged Type Nozzle Holder
to suit 1/2" Pipe

('O' ring included)
with diaphragm check valve

Suits quick coupling cap

Screw also supplied

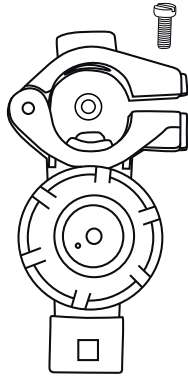

STAB024

Clamp Type Nozzle Holder
to suit 1/2" Pipe

('O' ring included)
with diaphragm check valve

Suits quick coupling cap

Screws also supplied

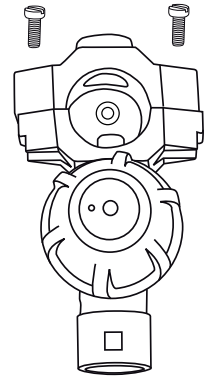

Dry boom nozzle bodies only

STAB009

3/8" Barbed Elbow
Nozzle Holder

With 1/4" FBSP thread

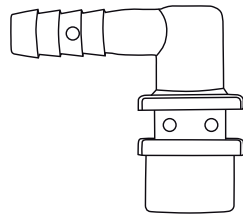

STAB007

3/8" Barbed Tee
Nozzle Holder

Suits quick coupling cap

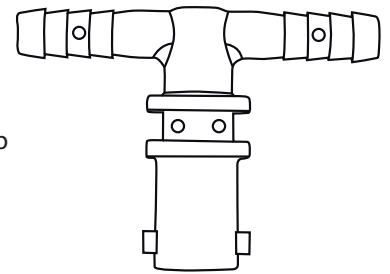

STAB008

3/8" Barbed Cross
Nozzle Holder

Suits quick coupling cap

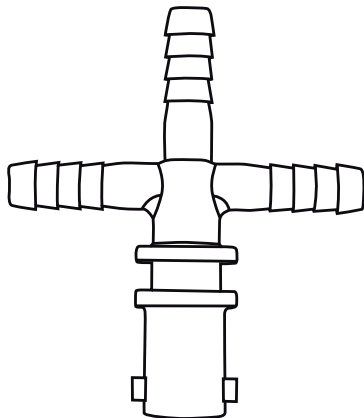

STAB006

3/8" Barbed Elbow
Nozzle Holder

Suits quick coupling cap

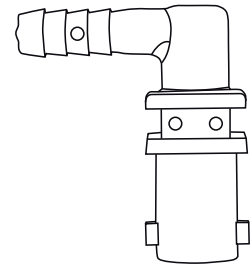

STAB011

1/4" BSP Swivel Nozzle Holder
& 3/8" Brass Nut

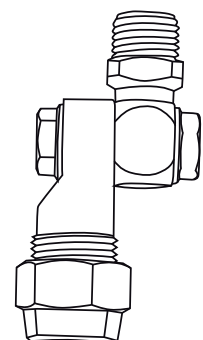

Other Components

STAB023

1/4" BSP M & F Ball Valve

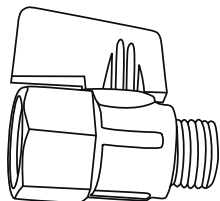

STAB005

100 # Screen Filter

To suit Tee Jet compatible nozzle bodies

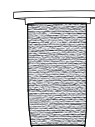

STAB013

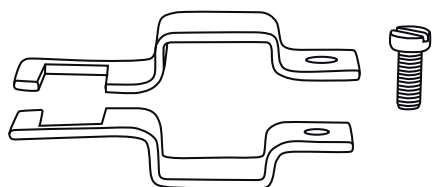

1" Variable Spacing Clamps

Suits STAB006, STAB007, STAB008 & STAB009, STAB025, STAB026 & STAB042 nozzle holders

OC4

Brass Off Centre End Jet

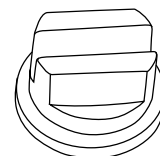

STAB010

Quick Coupling Cap & Washer for Nozzle Holder



NOZZLES

110° Flat Fan Polymer Nozzles

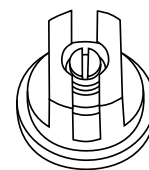
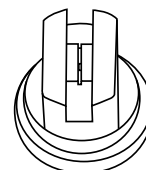

5 sizes:

STAB001	SF .01	Orange
STAB001-5	SF .015	Green
STAB002	SF .02	Yellow
STAB003	SF .03	Blue
STAB004	SF .04	Red